

# 384CTK SUMMIT®





Complete Toilet Kit, Elongated Front, SmartHeight™, Vitreous China, Two-Piece Toilet



## FEATURES

- Complete toilet kit (CTK)
- High performance MagnaFlush™ flushing technology
- 1.6 gpf / 6.0 lpf low water consumption
- Elongated front, SmartHeight™ bowl (ADA compliant)
- SmartFasten™ 3-bolt tank-to-bowl connection
- PuraClean® easy-to-clean glaze
- 3" Rigid Flapper flush valve – requires less force to flush, is more consistent and uses a simple universal repair part/seal
- Fluidmaster® pilot operated anti-siphon fill valve
- 12" rough-in
- Model 57 chrome-plated, metal trip lever
- 2" glazed trapway
- The Mansfield® limited lifetime warranty on china;  
Five-year limited warranty on tank trim
- Available in White, Biscuit and Bone



<b>MODEL 384CTK</b>			
Toilet seat included	ELONGATED	SMARTHEIGHT ADA	CTK
Complete toilet kit			

## COMPONENTS

MODEL #	DESCRIPTION	CODES/STANDARDS
<b>384CTK</b>	Elongated front, SmartHeight™, two-piece toilet kit. Includes: toilet seat, wax toilet ring, floor bolts, caps, and multi-lingual installation instructions. Water supply hardware not included. Specify color.	 
<b>384</b>	Elongated front, SmartHeight™ toilet bowl only. Less supply. Specify color.	
<b>386</b>	Tank and cover only, with left hand, front-mount, chrome-plated, metal trip lever. Less supply. Specify color.	
<b>3800</b>	Elongated, slow close CTk seat	

TANK TRIM & REPLACEMENT PARTS	
<b>57</b>	Trip lever - chrome-plated, metal trip lever, left hand
<b>2037-1212</b>	Summit® 1.6 rigid flapper flush valve
<b>400A</b>	Fluidmaster® anti-siphon pilot fill valve
<b>2206</b>	Anti-siphon pilot fill valve (compatible replacement)
<b>630-0030</b>	Replacement flush valve seal
<b>386-LID</b>	Tank lid





# 384CTK SUMMIT®



Complete Toilet Kit, Elongated Front, SmartHeight™, Vitreous China, Two-Piece Toilet

## SPECIFICATIONS

MODEL #	DESCRIPTION	CODES/STANDARDS
384-386	Elongated front, SmartHeight™ (1.6 gpf/6.0 lpf) two-piece toilet kit	 

MATERIAL	Vitreous China
WATER PRESSURE RANGE	20 to 80 PSI
FLUSH SYSTEM	MagnaFlush™ flushing technology
WATER USAGE	1.6 gpf / 6.0 lpf
WATER SURFACE AREA	9' X 10'
ROUGH-IN	12'
MAP RATING	1,000 grams

TRAP DIAMETER	2'
TRAP SEAL	2-3/8'
SHIPPING WEIGHT	Model 384CTK - 95 lbs. (43 kg)
WARRANTY	Vitreous China - Limited Lifetime Tank Trim - Limited Five Year

## TECHNICAL INFORMATION

**Note:** these dimensions are nominal and subject to change without notice.

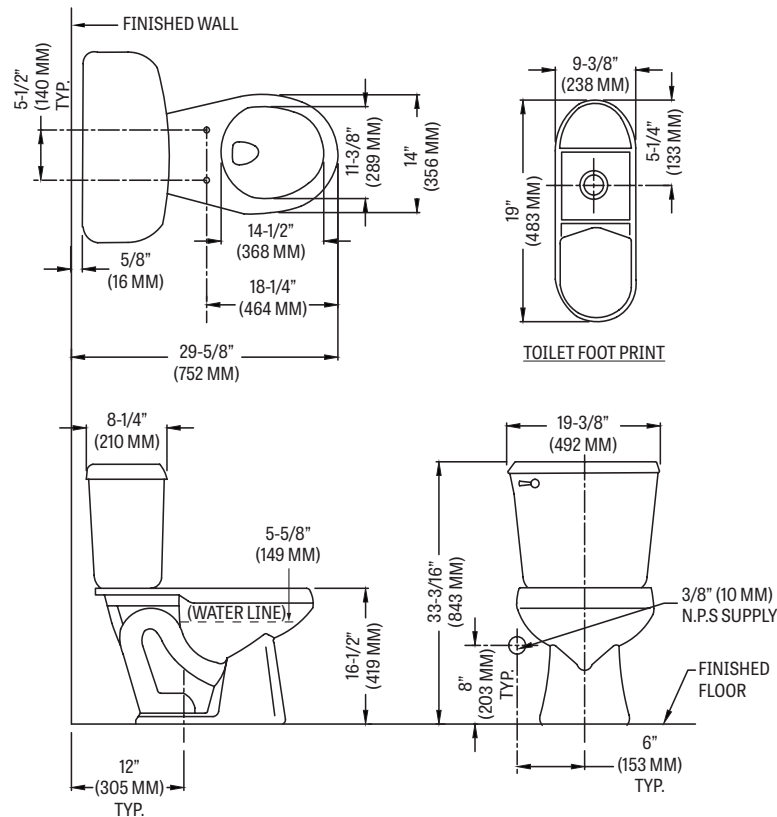

Fixture performance and specifications meet or exceed ASME A112.19.2/CSA B45.1 standards, and other state and local codes.

